

# **USER GUIDE**

**ReSound X-plore CIC  
(Completely-in-the-Canal )  
and MC (MiniCanal)**



**XE10/XE10-P/XE10-B/XE10-BP  
XE20/XE20-P**



**X-plore™**  
ReSound

## ReSound X-plore™

Your new digital ReSound X-plore™ hearing instruments will enable you to hear sounds that you may not have heard in years because of your hearing loss. Practice and a positive attitude are important in learning to use hearing instruments. While some people adjust quickly to wearing hearing instruments in their ears and hearing the new sounds, other people may need more time.

The intent of this user guide is to provide information on the many aspects of using hearing instruments. Your hearing instruments have been adjusted to your hearing loss by your hearing care professional. Familiarising yourself with the functions of your new hearing instruments will help you get optimal benefit.

*ReSound X-plore™ is a trademark of GN ReSound A/S.*

## Contents

## Page

Illustration of the hearing instrument . . . . .	4-5
Adjusting to a world of new sounds . . . . .	6
New sounds . . . . .	6
How to adjust . . . . .	7
How to use the hearing instrument . . . . .	8
On/off function . . . . .	8
SmartStart . . . . .	8
Inserting the hearing instrument . . . . .	9
Volume control (optional for XE20/XE20-P) . . . . .	10
Removing the hearing instrument . . . . .	11
Programme selector . . . . .	12
Stand-by function . . . . .	13
Telephone use . . . . .	14-15
Low battery warning . . . . .	16
Changing the battery . . . . .	16
When not in use . . . . .	16
Maintenance . . . . .	17
Daily maintenance . . . . .	17
Cleaning and replacing the sound filters . . . . .	18
Warnings and precautions . . . . .	19-21
Repairs . . . . .	22
Technical data . . . . .	23
Troubleshooting . . . . .	24-25
Key word index . . . . .	26-27

## ReSound X-plore™ CIC

1. Programme Selector
2. Battery Compartment & On/Off Switch
3. Sound Outlet
4. Microphone Sound Inlet
5. Removal Cord
6. Air Vent
7. Serial number
8. Model
9. Manufacturer

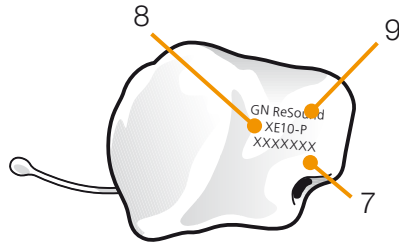
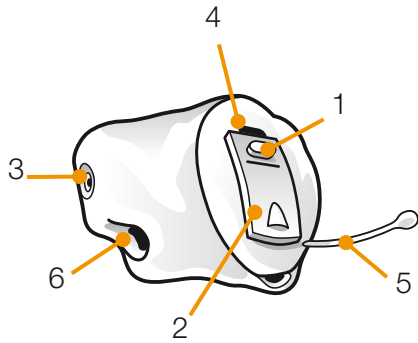

## ReSound X-plore™ MiniCanal (MC)

1. Programme Selector
2. Battery Compartment & On/Off Switch
3. Sound Outlet
4. Microphone Sound Inlet
5. Volume Control
6. Removal Cord
7. Serial number
8. Model
9. Manufacturer

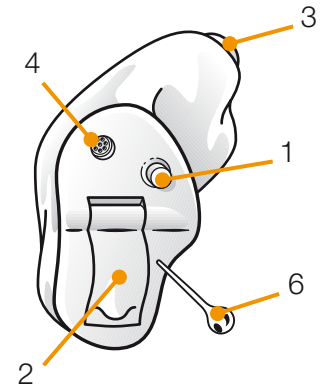
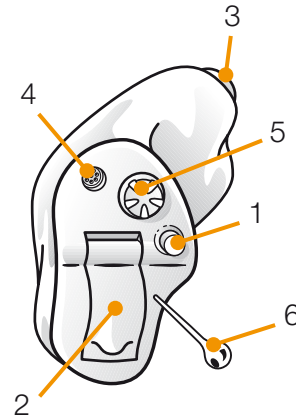

## Adjusting to a World of New Sounds

### New Sounds

A hearing loss is typically acquired gradually over many years. You may have become accustomed to an everyday life with fewer sounds, which also means hearing less noise than people with normal hearing.

With your new hearing instruments you will experience many sounds that you may not have heard for years. It will take time to get used to all these sounds again. Some examples of these sounds are:

- The clock ticking
- Turning pages of the newspaper
- Children's voices
- Whispers and soft speech
- Car noise
- Birdsong
- The sound of your own footsteps

### How to adjust

If you are inexperienced with hearing instruments it is advisable to:

1. Use your hearing instruments every day
2. Wear your hearing instruments for just a couple of hours a day during the first week
3. Gradually increase time you wear your hearing instruments.

It can take several months for your brain to get used to all the “new” sounds around you. Start using your hearing instruments in mainly quiet surroundings and start with a comfortable volume (the hearing care professional will ensure this). Listen to and get familiar with all sounds in your home, such as a ticking clock, water running in the sink, or silverware used on a plate. In quiet surroundings, converse with a person you know well. Listen to a TV or radio at home. After you have used the hearing instruments for a while you will be ready for more demanding listening situations, like conversation with a group of two or three people.

## How to Use the Hearing Instrument

### On/Off Function

Your ReSound X-plore™ hearing instrument is equipped with an on/off switch integrated into the battery compartment.

1. When the battery compartment is fully closed, the instrument is turned on
2. To turn the instrument off, open the battery compartment. Many individuals use their fingernail to pull it open.
3. Whenever you are not using the instrument, remember to turn it off to stop battery consumption

### SmartStart

SmartStart allows you to insert the instrument in your ear without the hearing instrument squealing. It delays the switch-on time by 10 seconds after closing the battery compartment. A beep each second is presented during this time.

## Insertion of the Hearing Instrument

### To insert the hearing instrument into your ear:

1. Hold the instrument with your thumb and fore-finger (as shown), either above and below or on the sides (as illustrated)
2. Place the sound outlet portion into your ear canal
3. Insert the instrument into your ear canal

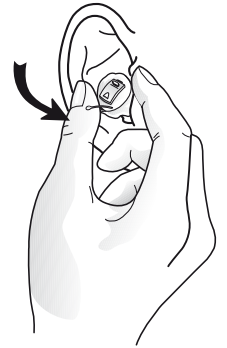

### Note:

It may be helpful to pull your ear up and outward, with your opposite hand, while inserting.

By experimenting, you may find a method that is easier for you. When properly inserted, the instrument should fit comfortably and tightly in your ear. It is important that the custom shell fits correctly into your ear. If the hearing instrument irritates your ear in any way please contact your hearing care professional to have the custom shell modified. You should never attempt to modify the shape of the custom shell yourself.

### Tip

Opening and closing your mouth can ease insertion.

## Volume Control on MC (optional)

Your ReSound X-plore™ XE20 / XE20-P hearing instruments have an optional volume control. When using the instrument, you can increase the volume by turning the volume control forward (towards your face when you are wearing the instrument) and reduce volume by turning it backward.

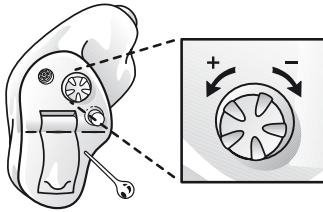

For each volume step, you will hear a “beep” signal indicating the change. The loudness of the “beeps” will increase as you turn the volume up and decrease as you turn it down. If you reach the upper or lower limit of the volume control range, there will be a different type of “beep” signal with a lower pitch.

## Removing the Hearing Instrument

To remove the hearing instrument, simply pull the removal cord with your thumb and forefinger and pull outward. Consult your hearing care professional if you have difficulty removing the hearing instrument.

## **Programme Selector (Standard on XE10-B/XE10-BP and optional on XE20/XE20-P)**

You can have up to three different programmes on your hearing instrument. The selection of programmes can be changed by your hearing care professional.

1. You can switch between programmes by pushing the programme selector once
2. You will then hear one or more “beeps”. The number of beeps indicates which programme you have selected
3. You can always return to programme 1 by turning your instrument off and then on again, or by placing it in stand-by mode and then returning to its operating mode

### **Your Programme Environments:**

(to be completed together your hearing care professional):

Programme	Description of when to use
1	
2	
3	

## **Stand-by Function**

In stand-by mode, the hearing instrument will not process sound or deliver an acoustic signal to the ear. When in this mode, a small amount of power will be used. To put the instrument in stand-by mode, hold down the programme selector for 5 seconds. You will hear a series of beeps and the device will be in stand-by mode. To return to standard mode, press the programme selector once. This can only be done after at least 5 seconds in the stand-by mode.

## Telephone Use

You can use the telephone with your hearing instruments. Using the telephone while using your hearing instruments may require some practice.

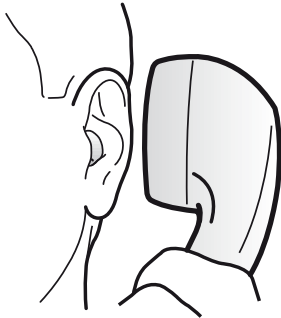

On occasion, you may notice a whistling (feedback) when the telephone is held close to the hearing instrument. To reduce the potential for this problem, your hearing instrument is equipped with an adaptive digital feedback suppression system (Dual Stabilizer DFS) which allows for use of the telephone while greatly reducing the risk of feedback. Hold the phone close to the hearing instrument, but not directly on it. If there is feedback, it may take a few seconds for the instrument to adapt and eliminate it.

## Cellular phone

If you use a cellular phone you may experience a buzzing or clicking noise. This is caused by the strong signal of the cellular phone. Consult with your hearing care professional for options to improve the sound quality.



## Low Battery Warning

Your hearing care professional can activate a Low Battery Warning function in your hearing instruments. When the battery voltage/power decreases to a certain level, the instrument will emit five soft beeping signals. This sequence will continue every five minutes until the instrument automatically switches off. It is recommended that you keep a spare battery at hand.

## Changing the Battery

1. Open the battery compartment completely by using your fingernail
2. After removing the old battery, insert the new one
3. Always use Zinc-Air size 10A

It is important to insert the battery with the positive side in the correct position.

The battery door has a + marking to help determine correct insertion.

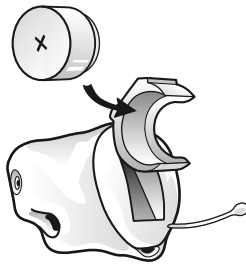

## When not in use

Removing the battery when you are not wearing the instrument for a longer period will help prevent corrosion of the battery contacts.

## Maintenance

### Daily Maintenance

It is important to keep your hearing instrument clean and dry every day. To clean the instrument, use a soft cloth. If the instrument has been exposed to high humidity or perspiration, use a drying kit that is available from your hearing care professional.

### To avoid the need for repairs:

1. Never immerse the instrument in water or other liquids since this may cause permanent damage to the hearing instrument
2. Protect your hearing instrument from rough handling, and avoid dropping it on hard surfaces or floors
3. Do not leave the instrument in or near direct heat or sunlight since excessive heat can damage the instrument or deform the casing

## **Cleaning and Replacing the Sound Filters**

### **Cleaning the Microphone Sound Inlet**

For proper function of the microphone, it is important to clean the sound inlet to remove dust or other sound-disturbing debris. The soft brush, provided with your hearing instrument, can be used for this purpose. Your hearing care professional can instruct you on how to properly use this tool.

### **Changing the Sound Outlet Filter/Cleaning the Sound Outlet**

Your ReSound X-plore™ hearing instrument may be equipped with a sound outlet filter (consult your hearing care professional). This filter is located at the end of the sound outlet and prevents debris from getting into the hearing instrument. If the hearing instrument seems to have lost power, and changing the battery does not help, the filter may be blocked, and needs to be changed. Your hearing care professional can instruct you on how to change the filter.

If your hearing instrument does not have a filter, ear wax and/or other debris may accumulate in the sound channel. The cleaning loop, provided with your hearing instrument, can be used to remove this material. Your hearing care professional can instruct you on how to properly use this tool. When using this tool, be careful not to damage or pull the tubing placed at the opening of the sound outlet. If this is pulled out, the hearing instrument may need to be returned for repair.

## **General Precautions**

1. Do not leave your hearing instrument in the sun, near an open fire or in a hot, parked car
2. Do not wear your instrument while showering, swimming, in heavy rain or in a moist atmosphere such as steam bath or sauna
3. Should your hearing instrument become wet or moist, use the drying kit that your hearing care professional has recommended. Do not place the hearing instrument in a very warm place to remove moisture (for example, the oven or use a hair dryer). Direct or indirect heat can damage the instrument.
4. Remove your hearing instrument when applying such things as cosmetics, perfume, aftershave, hair spray, and suntan lotion. These might get into the instrument and cause damage.

## General Warnings

1. Consult a physician if you discover a foreign object in your ear canal, if you experience skin irritation or if excessive ear wax accumulates with the use of the hearing instrument
2. Different types of radiation, e.g. from NMR, MRI or CT scanners, may damage the hearing instrument. Therefore, do not wear the hearing instrument during these or other corresponding scanning procedures. Other types of radiation (burglar alarms, room surveillance systems, radio equipment, mobile telephones, etc) contain less energy and will not damage the hearing instrument. They could, however, momentarily affect the sound quality or create strange sounds from the hearing instruments
3. Do not wear the hearing instrument in mines or other explosive areas, unless those areas are certified for hearing instrument use
4. Do not allow others to use your hearing instrument. It may cause permanent damage to their hearing
5. Hearing instrument usage by children or mentally challenged persons should be supervised at all times
6. Hearing instruments should be used only as prescribed by your hearing care professional. Incorrect use may result in sudden and permanent hearing loss

## Battery Warning Information

1. Keep batteries away from children and mentally challenged persons
2. Batteries can be harmful if swallowed. If you do, seek medical help immediately
3. Do NOT attempt to recharge batteries which are not specifically designated rechargeable as they may leak or explode
4. Do NOT attempt to dispose batteries by burning them
5. Replace spent batteries, and do not leave them in the instrument for a prolonged period. If your hearing instrument is equipped with a low battery warning feature, replace battery immediately after low battery warning is reached
6. Used batteries can be harmful to the environment. Please dispose of them according to local regulations or return them to your hearing care professional.

## Repairs

If your ReSound hearing instrument malfunctions it must be repaired by a qualified technician. Do not attempt to open the case of the hearing instrument since this will invalidate the warranty. If your hearing instrument requires service, please contact your hearing care professional for assistance.

## Technical Data

Maximum Output (2cc Coupler / IEC 60118-7)

XE10	108 dB SPL (Typical)
XE10-P	113 dB SPL (Typical)
XE10-B	108 dB SPL (Typical)
XE10-BP	114 dB SPL (Typical)
XE20	108 dB SPL (Typical)
XE20-P	113 dB SPL (Typical)

## Troubleshooting Guide

SYMPTOM	CAUSE	POSSIBLE REMEDY
<b>No sound</b>	<ul style="list-style-type: none"><li>• Stand By Mode</li><li>• Not turned on</li><li>• Dead battery</li><li>• Battery improperly inserted</li><li>• Blocked sound outlet filter</li></ul>	<ul style="list-style-type: none"><li>• Re-activate by pushing the programme selector once</li><li>• Turn on by closing the battery door</li><li>• Replace battery</li><li>• Insert battery properly</li><li>• Change filter or consult your hearing care professional</li></ul>
<b>Not loud enough</b>	<ul style="list-style-type: none"><li>• Change in hearing</li><li>• Excessive ear wax</li><li>• Blocked sound outlet filter</li><li>• Volume set too low</li></ul>	<ul style="list-style-type: none"><li>• Reinsert carefully or consult your hearing care professional</li><li>• Consult your physician</li><li>• Change filter or consult your hearing care professional</li><li>• Consult your hearing care professional</li></ul>
<b>Squealing</b>	<ul style="list-style-type: none"><li>• Instrument not inserted correctly</li><li>• Dual Stabilizer II needs re-initialization</li><li>• Build-up of earwax</li><li>• Instrument settings not optimal</li></ul>	<ul style="list-style-type: none"><li>• Remove and reinsert</li><li>• Consult your hearing care professional</li><li>• Consult your physician</li><li>• Consult your hearing care professional</li></ul>
<b>Sound not clear or distorted</b>	<ul style="list-style-type: none"><li>• Weak battery</li><li>• Hearing instrument damaged</li><li>• Hearing instrument settings not optimal</li></ul>	<ul style="list-style-type: none"><li>• Replace battery</li><li>• Consult your hearing care professional</li><li>• Consult your hearing care professional</li></ul>

If there are any other problems not mentioned in this guide, please contact your hearing care professional.

## Key Word Index

Adjusting to the hearing instrument . . . . .	6
Battery change . . . . .	16
Battery compartment . . . . .	4
Cerumen/earwax . . . . .	18,24
Cleaning the instrument. . . . .	17
Inserting the hearing instrument. . . . .	9
Low battery warning . . . . .	16
Maintenance . . . . .	17
On/off switch. . . . .	4,8
Precautions . . . . .	19
Programme Selector . . . . .	4,12
Removing the hearing instrument . . . . .	11
Repairs . . . . .	22
Sound disappeared. . . . .	24
Sound outlet filter . . . . .	18
Stand-by mode . . . . .	13
Technical data . . . . .	23
Telephone use. . . . .	14

Troubleshooting guide . . . . .	24
User operated controls . . . . .	8
Warnings. . . . .	20
Volume Control . . . . .	4
Squealing . . . . .	24



Please ask your local hearing care professional concerning disposal of your hearing instrument



Faceplate/Electronics by: GN ReSound A/S

Any issues relating to the EU Medical Device Directive 93/42/EEC should be directed to GN ReSound A/S.

# ReSound



rediscover hearing

## **Worldwide Headquarters**

GN ReSound A/S  
Lautrupbjerg 7  
DK-2750 Ballerup, Denmark  
Tel.: +45 45 75 11 11  
Fax: +45 45 75 11 19  
[www.resound.com](http://www.resound.com)

## **United Kingdom**

GN ReSound Ltd.  
1 Landscape Close  
Weston Business Park  
Weston-on-the-Green  
Oxon OX25 3SX  
Tel.: 0 1869 352 800  
Fax: 0 1869 343 466  
[www.gnresound.co.uk](http://www.gnresound.co.uk)

## **Australia**

GN ReSound Pty. Ltd.  
Unit R1 Regent Park Estate  
391 Park Road  
Regent Park NSW 2143  
Tel.: (free) 1800 658 955  
Fax: 02 9743 7472  
[www.gnresound.com.au](http://www.gnresound.com.au)

## **New Zealand**

GN ReSound (NZ) Ltd.  
12 Parkway Drive  
Mairangi Bay  
Auckland  
Tel.: (free) 0800 900 126  
Fax: (free) 0800 007 695  
[www.gnresound.co.nz](http://www.gnresound.co.nz)